



ST700V10

AUTOMATIC SKINNING MACHINE - SHORT MODEL

MODEL



TECHNICAL DATA

FEATURE	DATA
Operators	1-2
Voltage range (1)	220- 480V 50-60Hz
Power (1)	1,6kW/3 ph
Controls	24V
LxWxH (2)	1880 x 1075 x 1257 mm
Weight (3)	360 kg
Working width (2)	480 mm
Water usage	8 l/m
Water connection	1/2"
Air usage	-
Air connection	-
Speed (4)	+/- 21 m per minute

(1) depending on requested voltage

(2) 1mm = 0,03937 inches

(3) 1kg = 2,20462 pounds

(4) $\left(\frac{2100\text{cm/min}}{\text{length fillet (cm)} + 5\text{cm}} \right) \times 2 = \text{theoretical capacity}$

DESCRIPTION

 Veelzijdige automatische onthuidmachine (korte transportbanden) geschikt voor veel vissoorten en –afmetingen (tot 50 mm in hoogte) met de mogelijkheid tot dieponthuiden. Bezoek onze website en bekijk de productmatrix in de algemene brochure voor meer informatie. Informeer STEEN bij het bestellen over de elektrische specificaties en beschikbare wateraansluiting. Informeer ons eveneens welke vissoorten (bij voorkeur de wetenschappelijke naam) u wenst te verwerken, ieder met hun capaciteit en algemene lengte. Gelieve aan te geven of u bijzondere vereisten heeft met betrekking tot het product.

 Peleuse automatique polyvalente adaptée à de nombreuses espèces et tailles de poissons (jusqu'à 50 mm) avec des possibilités sur peau profonde. Pour plus d'informations, veuillez consulter notre site Web et notre matrice de produits dans le dossier principal. Lors de la commande, veuillez fournir à STEEN les spécifications électriques et un raccord d'eau disponible. Indiquez-nous également quelle espèce de poisson (de préférence le nom scientifique) vous souhaitez traiter, y compris sa capacité et sa longueur générale. Veuillez aussi indiquer si vous avez des exigences particulières concernant le produit.

 Vielseitige automatische Enthäutungsmaschine, für viele Fischarten und -größen (bis zu 50 mm Höhe) geeignet, mit der Möglichkeit des tiefen Enthäutens. Weitere Informationen finden Sie auf unserer Website und in der Produktmatrix im Hauptverzeichnis. Bitte teilen Sie STEEN bei der Bestellung die elektrischen Daten und den verfügbaren Wasseranschluss mit. Teilen Sie uns bitte auch mit, welche Fischarten (vorzugsweise der wissenschaftliche Name) Sie mit welcher Kapazität und welcher allgemeinen Länge verarbeiten möchten. Bitte geben Sie auch an, ob Sie besondere Anforderungen an das Produkt haben.



FOOTPRINT

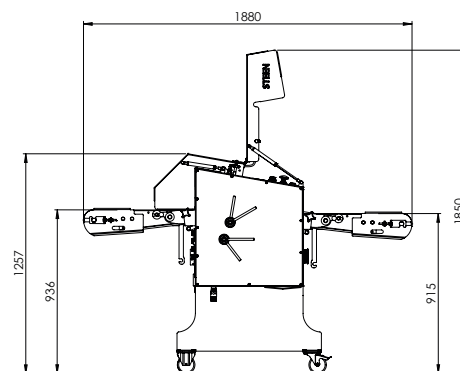
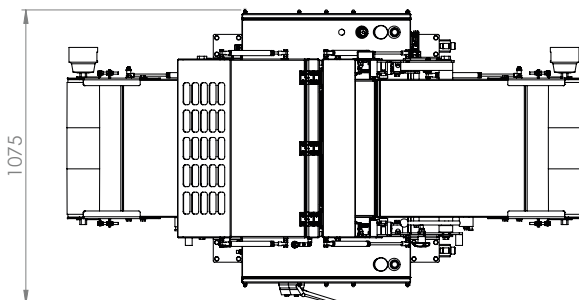

Due to the high degree of customization possibilities, technical data of the final product may vary.









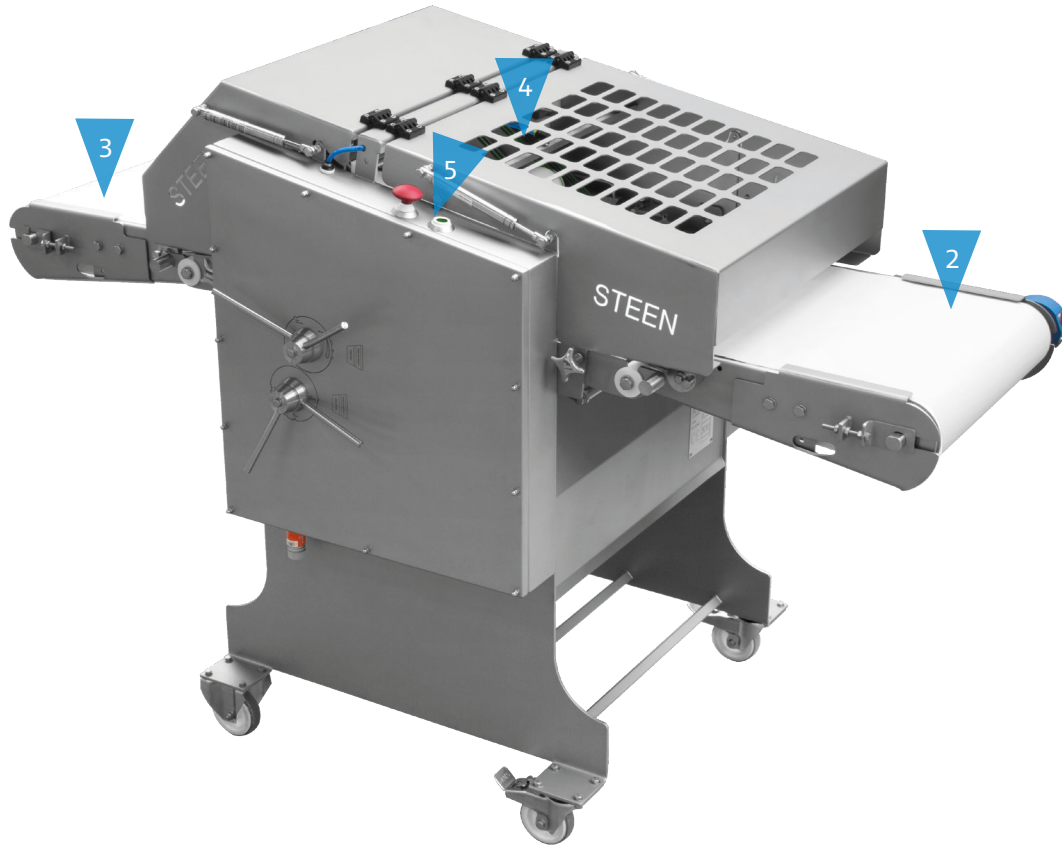

OPTIONS



ST700V10

AUTOMATIC SKINNING MACHINE - SHORT MODEL

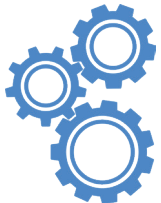

<p>700/TABLE 1</p>  <p>Infeed table</p>	<p>700V/INFEED 2</p>  <p>Long infeed conveyor = +546mm</p>	<p>700V/OUTFEED 3</p>  <p>Long outfeed conveyor = +549mm</p>	<p>700V/BLADE 4</p>  <p>Extra blade for more possibilities (deepskin)</p>	<p>700V/SPEED 5</p>  <p>Speed regulator</p>
<p>700/3Z100 6</p>  <p>Table for storing knife and dispose blades.</p>			<p>CLEANING</p>  <p>Cleaning mode</p>	<p>CUSTOMIZED 7</p>  <p>Tailor-made solution</p>

Due to the high degree of customization possibilities, technical data of the final product may vary.